

M

manitou

M37Z&R



SERVICE GUIDE



MANITOU

5800 W Donges Bay Rd
Mequon, WI 53092

manitoumtb.com

888.686.3472

Support: manitoumtb.com/support

Warranty:

For full warranty information please visit hayesbicycle.com/warranty

HAYES

m
manitou

PROTAPER

REYNOLDS

SUN
ringle

WHEELSMITH
W
SPOKES

HAYES
PERFORMANCE SYSTEMS

INTRODUCTION

This manual is intended to guide the user through the steps necessary to fully service and maintain the Mezzler Pro and Mezzler Expert suspension fork.

⚠ WARNING ⚠

We highly recommend that service to this fork be performed by a certified bicycle mechanic. Failure to follow instructions presented in this manual could lead to serious injury or death. Any questions about the servicing of this fork or the manual itself should be directed to Hayes Customer Support at:

Hayes Bicycle USA	5800 W Donges Bay Road Mequon WI 53092
	Phone: 888.686.3472
	Email: techsupport@hayesbicycle.com

Hayes Bicycle Europe	Dirnismaning 20 a 85748 Garching (b. Munich) Germany
	Phone: +49 89 203237450
	Email: techsupportEU@hayesbicycle.com

Hayes Bicycle Asia	16F, No. 37, Sec. 3 Mincyuan E. Rd. Zhongshan District Taipei City 10476 Taiwan ROC
	Phone: 886-2-2518-1108

TABLE OF CONTENTS

SECTION	PAGE NUMBER
Required Tools	5
Casting Removal & Service	6-8
Air Spring Service	9-13
Pro Damper Service	14-18
Pro Casting Install	19-21
Pro Compression Knob Installation	22
Expert Damper Service	23-24
Expert Casting Install	25-27
Expert Damper Install	28-29
Travel Change (Optional)	30-33
Mezzer Expert IVA settings	34
Exploded Views	35-42

REQUIRED TOOLS

Below is a list of tools necessary for changing the travel on the Mezzler fork.

- Safety Glasses
- Nitrile Gloves
- Lint-Free Rags
- Torque Wrench (6-220 in-lb [0.7-25 Nm])
- 2mm Hex Wrench
- 8mm Hex Wrench
- 14mm Box End Wrench
- Shock Pump
- Cassette Lockring tool* (e.g. Park tool FR-5.2)
- 1" socket
- 8mm Socket *
- 24mm Socket *
- (Optional, replaces items above with*) Manitou Tool Kit - Manitou part number 172-31133 (This includes the Manitou Cassette Tool, 8mm thin wall socket, and flat ground 24mm socket)
- Travel Spacer kit 141-36713-K032

Below is a list of additional tools necessary for a full service of the Mezzler fork.

- 11mm Socket (Pro Only)
- Plastic or non-marring pick
- Downhill tire lever or flat blade screwdriver
- 5wt Maxima Fork oil - Manitou part number 85-0023
- Semi-bath Oil, 5/40w Synthetic - Manitou part number 85-0022
- Slickoleum™ Grease
- Isopropyl alcohol
- 37mm seal install tool 172-37540-K002
- Cartridge Damper Bleed Kit 141-30694-K020 (Pro Only)
- 37mm seal kit 141-36713-K025 and Air piston Seal Kit 141-36713-K027 or Rebuild kit 141-36713-K026

CASTING REMOVAL & SERVICE

Manitou recommends a full service anytime the casting is removed. If the fork is new and only a travel change is needed, follow instructions 1-4 then skip to Page 31 for Travel change instructions. Return to page 19 for casting install.

- 1 Remove rebound knob using a 2mm Hex wrench.

Note: Be sure to hold the knob still while removing the screw. The damper adjuster may be damaged if the knob is over torqued.



- 2 Hold lock-nut with 14mm box end wrench. Insert a 8mm Hex wrench into the end of the rebound rod and loosen **clockwise** until rebound rod disengages from the lock-nut.

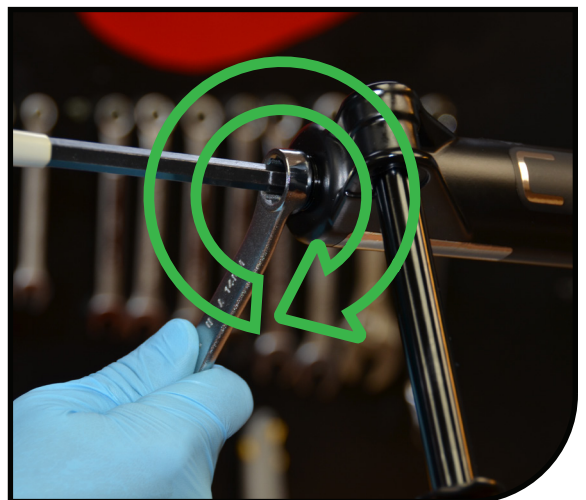

- 3 Unscrew air cap and attach shock pump. Depress pressure bleed button until pump reads "Zero". Depress Schrader Valve a few times with 2mm hex wrench to ensure all air is released.



CASTING REMOVAL & SERVICE

- 4** Hold lock-nut with 14mm box end wrench. Using 8mm Socket, turn the compression rod **clockwise** until compression rod is disengaged from the lock-nut.



- 5** Remove casting from fork. It is recommended this be done over a drain pan as the lower casting contains semi-bath oil. Allow oil in casting to drain out before continuing to next step.

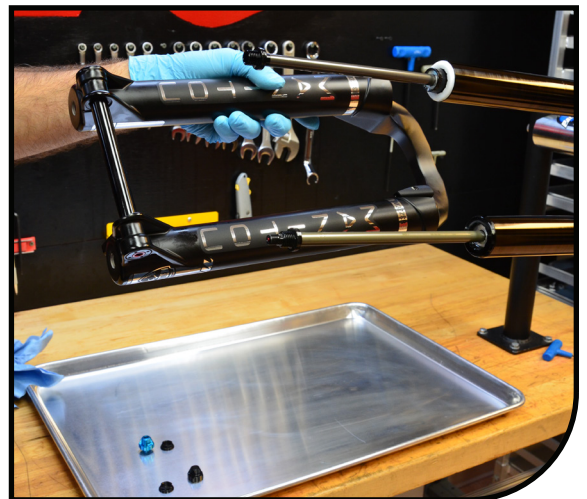

- 6** Using a downhill tire lever or similar tool, gently pry the dust seals out of the casting.

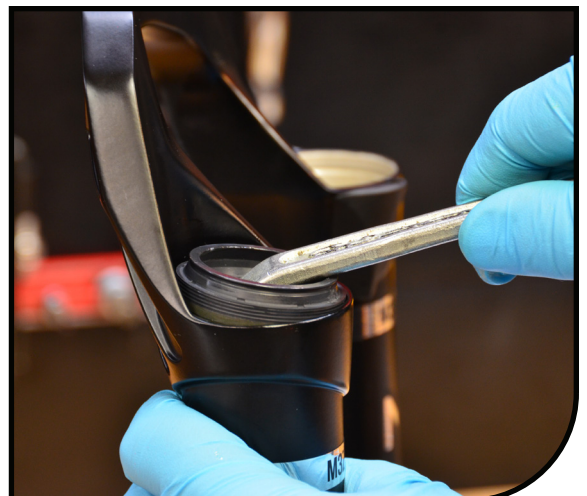

CASTING REMOVAL & SERVICE

- 7** Remove old foam wiper rings. Thoroughly saturate new foam rings with semi-bath fluid and install into fork casting.



- 8** Remove springs from outer lip of new leg seals. Clean casting seal press area with Isopropyl alcohol. Using the Manitou 37mm Seal Press press in the dust seals. Reinstall springs onto seals.

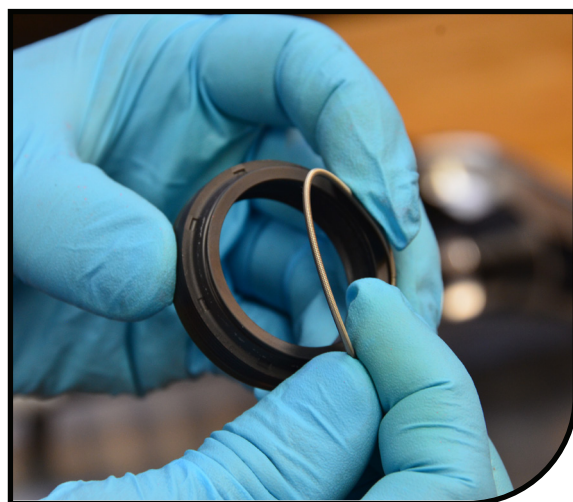

AIR SPRING SERVICE

1

Mezzer Pro: Remove IRT air cap. Make sure the air is released from the fork. Depress IRT Schrader Valve with a 2mm hex a few times to ensure all air is released.

Mezzer Expert: Skip to Step 2.



2

Mezzer Pro: Using a standard cassette tool and 1" socket loosen IRT cap until threads are free from leg.

Mezzer Expert: Using a 24mm socket loosen IVA cap until threads are free from leg.



3

Mezzer Pro: Pull IRT assembly straight out, Clean with isopropyl, Inspect seal for damage. If needed Replace IRT piston seals (141-36713-K026).

Mezzer Expert: Pull IVA assembly straight out, Clean with isopropyl, Inspect seal for damage. If needed replace IVA piston seals (141-36713-K026).



AIR SPRING SERVICE

4

Invert the fork and use Manitou cassette tool with adjustable wrench to unthread the air spring assembly from the stanchion. OR depress valve on end of comp-rod with 2mm hex and stroke rod to bottom. Slide standard cassette lock-ring tool over threaded adapter and unthread the air spring assembly from the stanchion.



5

Remove Air Spring Assembly, clean with isopropyl, Inspect seal for damage. Replace air piston seal (141-36713-K027). **If Travel change is need see page 26 before moving on.**

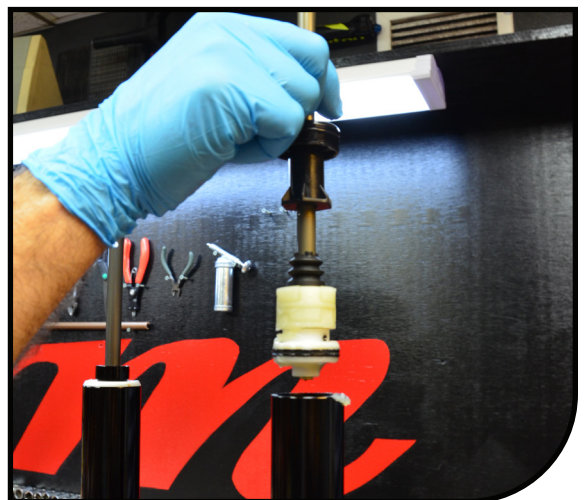

6

Once the air spring assembly is removed clean the inside of the stanchion with isopropyl alcohol and a lint free towel (Be careful to not scratch the inner surface of the stanchion). Inspect the inside and outside of the stanchion for scratches or other damage.



AIR SPRING SERVICE

7

Liberaly apply Slickoleum™ grease to the piston seal, outer piston surface, and spring shaft. Add 3cc's of Slickoleum™ grease to the top of the air piston.



8

Add Slickoleum™ grease to the stanchion threads before inserting the air spring assembly. Spread grease across entire thread surface.

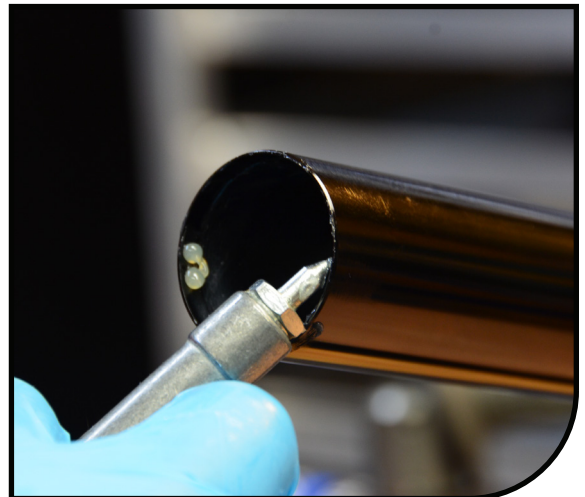

9

Install air spring assembly into stanchion. Using a 26mm crow's foot and Manitou cassette tool **OR** 1" Socket and Standard cassette tool torque to 20-25 in-lb [2.3-2.8 Nm]. If rod is bottomed attach shock pump to valve and draw the rod out until fully extended.

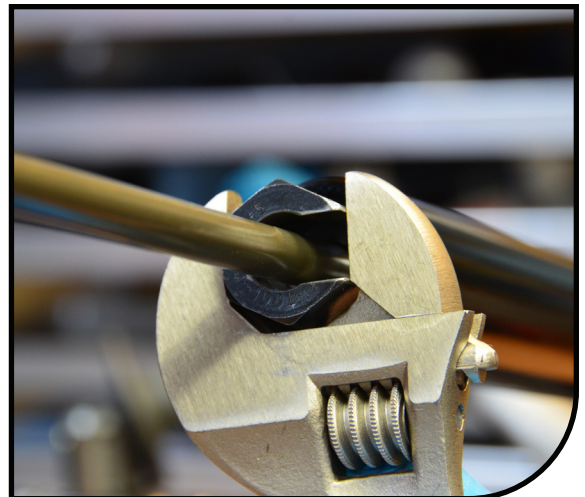

AIR SPRING SERVICE

10

Mezzer Pro: Liberally apply Slickoleum™ grease to the IRT piston seal, outer piston surface, and IRT shaft. Apply Slickoleum™ grease to the threads of the stanchion.

Mezzer Expert: Liberally apply Slickoleum™ grease to the IVA piston seal and outer piston surface. Apply Slickoleum™ grease to the threads of the stanchion.



11

Mezzer Pro: Insert IRT piston into stanchion. Apply even pressure to piston surface as you work the piston seal past the stanchion threads.

Mezzer Expert: Insert IVA Piston into the stanchion.

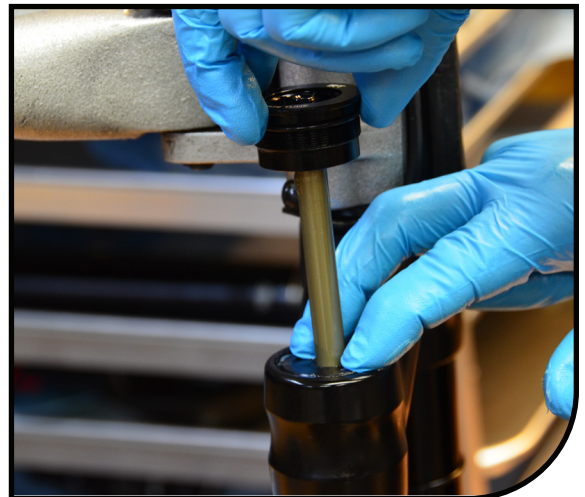

12

Mezzer Pro: Install IRT cap into stanchion. Torque to 220-220 in-lb [20-25 Nm] using standard cassette lock-ring tool.

Mezzer Expert: Install IVA cap into stanchion. Torque to 220-220 in-lb [20-25 Nm] using a 24mm socket.



AIR SPRING SERVICE

13 **Mezzer Pro:** Attach a shock pump and inflate IRT to 100PSI.

NOTE: ALWAYS SET IRT PRESSURE (TOP OF FORK) BEFORE DORADO AIR PRESSURE (BOTTOM OF FORK)

Mezzer Expert: Skip to step 14.



14 Attach a shock pump and inflate main air chamber to 60PSI. This will aid in installing the casting later.



PRO DAMPER SERVICE

- 1 Using a 2mm Hex wrench remove the screw of the red "LO-SPEED" MC2 knob.

Note: Be sure to hold the knob still while removing the screw. The damper adjuster may be damaged if the knob is over torqued.

EXPERT SKIP TO PAGE 23

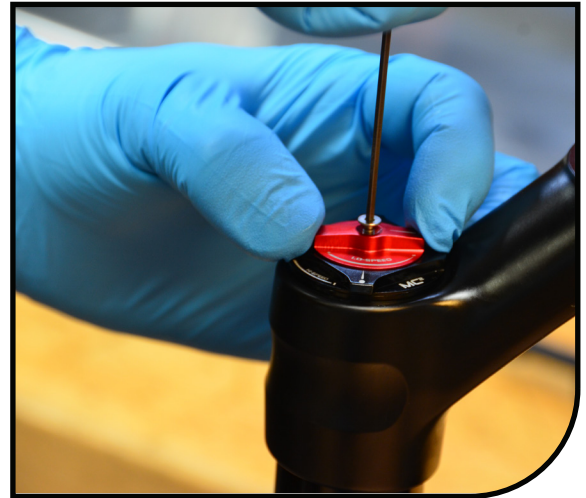

- 2 Use a non-marring pick or pliers with non-marring barrier to remove the red "LO-SPEED" compression knob by lifting straight up.



- 3 With a 11mm socket, unthread the exposed nut and remove the black "HI-SPEED" adjustment knob.

Note: Be sure to hold the knob still while removing the nut. The damper adjuster may be damaged if the knob is over torqued.



PRO DAMPER SERVICE

- 4** Remove the v-seal that was under the black "HI-SPEED" adjustment knob.



- 5** Use a standard cassette tool and 1" socket to unthread the damper top-cap from the stanchion.



- 6** Remove damper assembly from the stanchion. Inspect damper shaft and bladder for any damage.

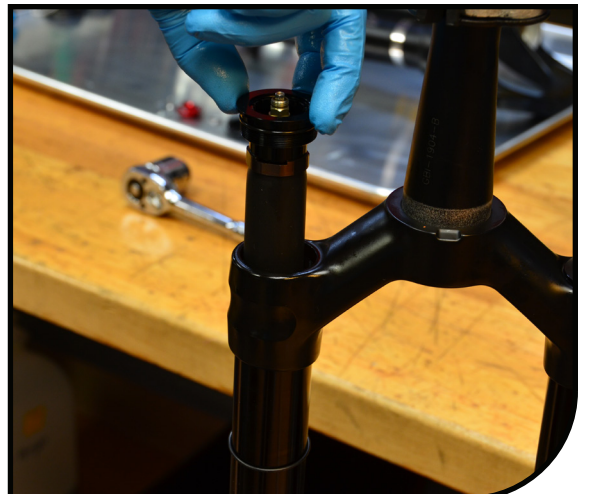

PRO DAMPER SERVICE

- 7** Pull damper shaft to full extension. Remove bleed-screw on side of top-cap. Place damper top-cap over catch pan. Cycle damper shaft several times to cycle out old oil from damper.

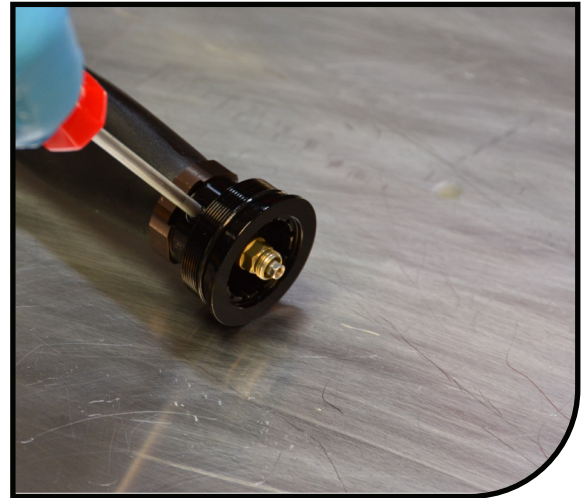

- 8** Attach M5x0.8 Luer lock fitting to both syringes (141-30695-K020). Fill one syringe with 5wt Damper oil (85-0023).

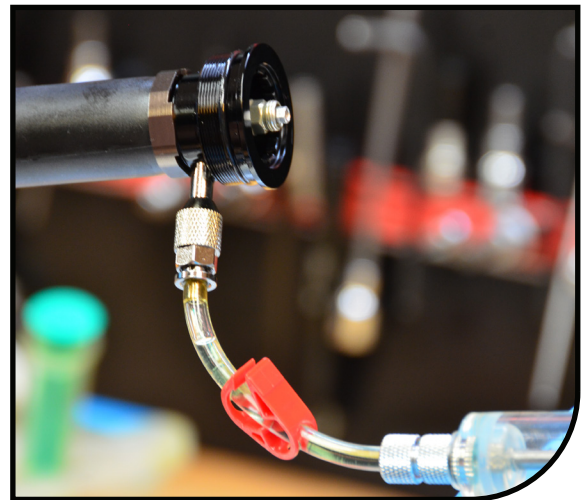

- 9** Attach the empty syringe M5x.8 adapter to top-cap bleed port. Remove bleed-screw from damper end-cap and attach the filled syringe M5x.8 adapter to end-cap bleed port.

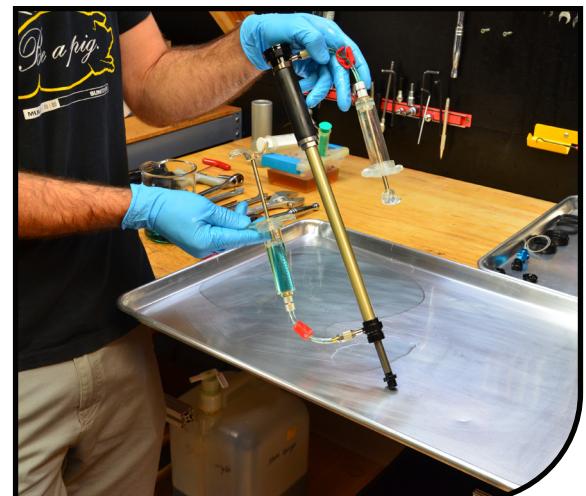

PRO DAMPER SERVICE

- 10** Holding the damper end-cap up-right in vise simultaneously compress the filled syringe and retract the empty syringe to remove air from the damper. Refill the syringe as needed until oil is drawn into the upper syringe.

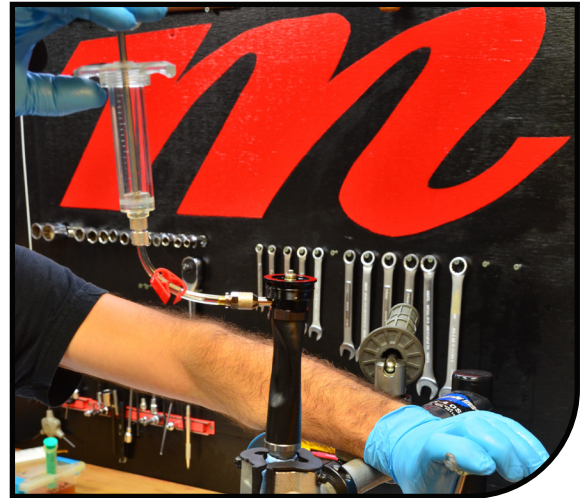

- 11** Closing the bleed hose clamp on both syringes cycle the damper SLOWLY to draw air to the top of the damper. Open bleed hose clamps and repeat step 10 until no air bubbles are present in oil drawn into upper syringe.

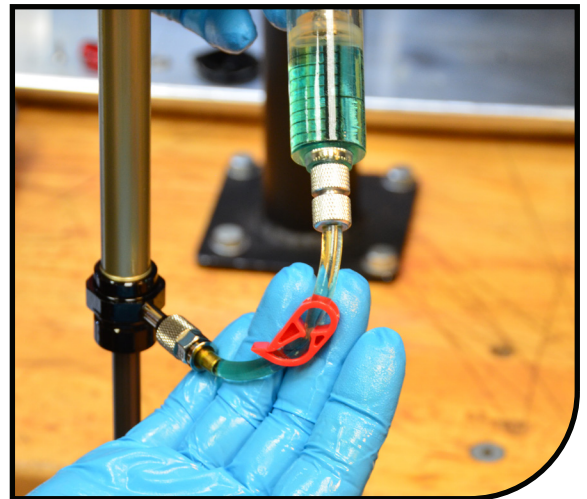

- 12** Fully extend damper shaft and add oil from bottom syringe until bladder is slightly expanded. Closing the bleed hose clamp on both syringes remove cartridge from vise. Lay cartridge flat on bench. Remove lower syringe and replace bleed screw. Some oil may discharge from bleed port when removing syringe. Remove upper syringe and replace bleed screw.

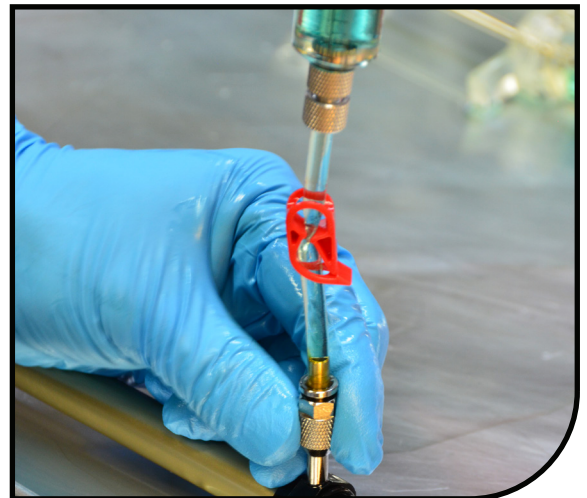

PRO DAMPER SERVICE

- 13 Install Damper cartridge into stanchion. Using standard cassette lock-ring tool Torque to 220-220 in-lb [20-25 Nm] .

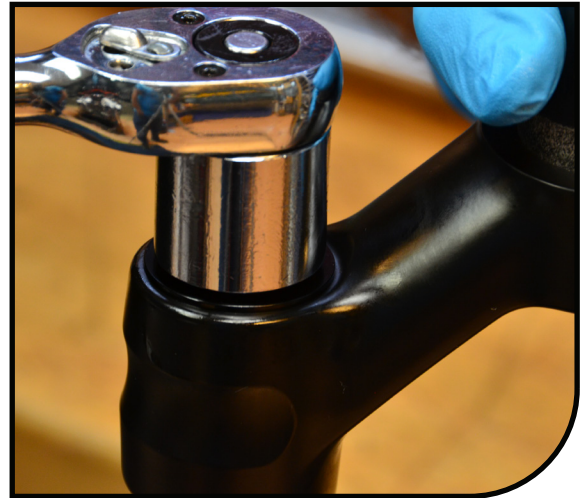

PROCASTING INSTALL

- 1 Apply a light coating of semi-bath (85-0022) to the inner diameter of the oil seal/dust wiper.



- 2 Make sure the spring shaft is fully extended and air chamber is filled with air (60PSI).



- 3 Fully extend the damper shaft.

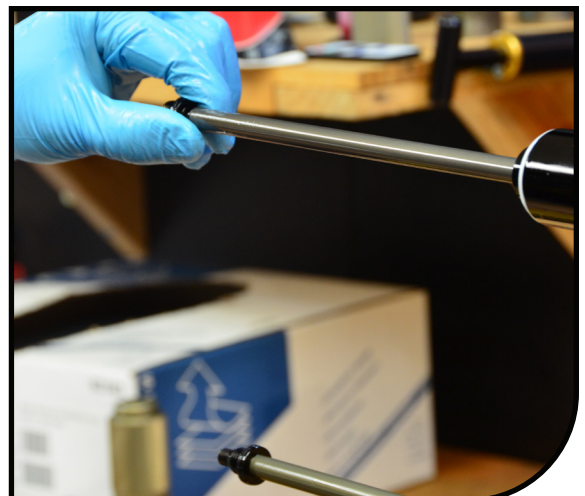

PROCASTING INSTALL

4 Slide casting onto the stanchion assembly. Only slide the casting down about halfway at this point. Take care that the seal lips do not fold over upon installation.

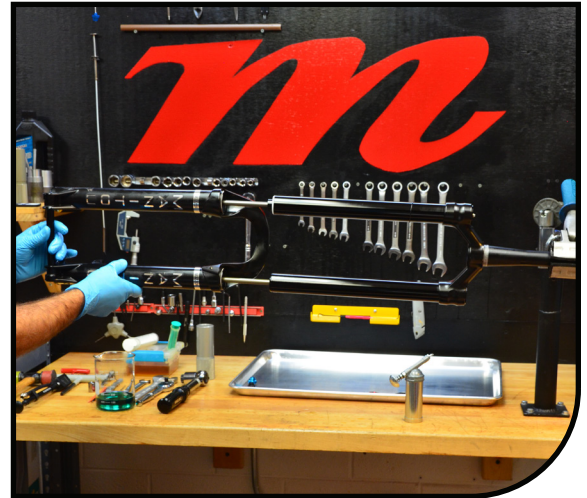

5 Insert 21cc of semi-bath (85-0022) into each casting leg. Once the semi-bath is in the legs slide the casting the rest of the way onto the stanchion assembly until the damper and spring shaft adapters pass thru the end of the casting. Some manual alignment may be needed.

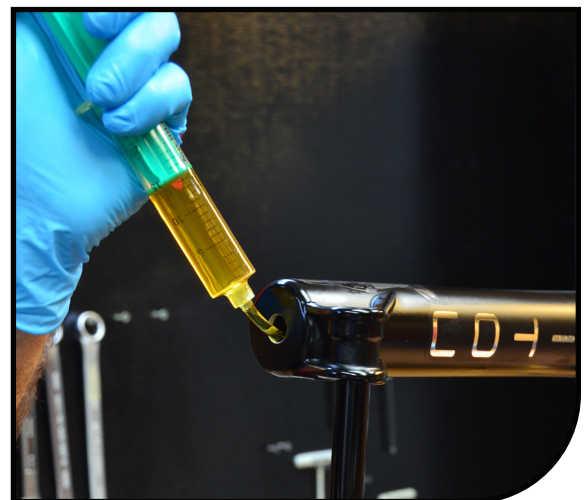

6 Thread the lock-nut onto the damper shaft adapter. Holding the lock-nut with a 14mm box wrench, use an 8mm Hex wrench to tighten the rebound damper adapter to 35–40 in-lb [3.95–4.5 Nm] by turning them **counter-clockwise**. Do not overtighten, doing so can damage the threads.



PROCASTING INSTALL

- 7** Install the rebound knob using a 2mm Hex wrench. Add a small drop of blue Loctite to the screw before installation to prevent the screw from backing out during riding.

Note: Be sure to hold the knob still while removing the screw. The damper adjuster may be damaged if the knob is over torqued.



- 8** Thread the other lock-nut onto the spring shaft adapter. Holding the lock-nut with a 14mm box wrench, use an 8mm socket tighten the compression rod adapter to 35–40 in-lb [3.95–4.5 Nm] by turning them **counter-clockwise**. Do not overtighten, doing so can damage the threads.

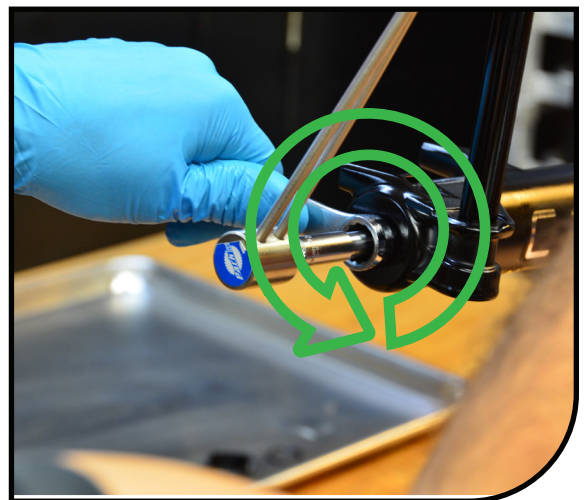

PRO COMPRESSION KNOB INSTALLATION

- 1 Clean the adjuster knobs with isopropyl and replace v-seal into top-cap counter-bore.
- 2 Install the black "HI-SPEED" adjustment knob onto adjuster hex. With a 11mm socket, thread on the lock nut and torque to 4-6 in-lb [0.5-0.7 Nm] Note: Be sure to hold the knob still while installing the nut. The damper adjuster may be damaged if the knob is over torqued.

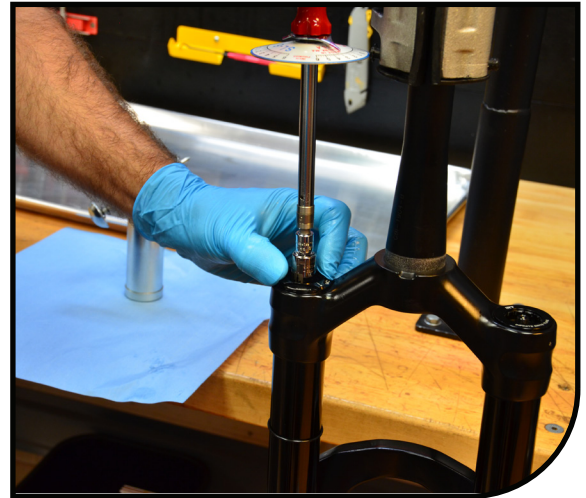

- 3 Lubricate o-ring seal on red "LO-SPEED" adjustment knob with Slickoleum™ Grease and install onto adjuster hex. With a 2mm hex, thread on the screw and torque to 4-6 in-lb [0.5-0.7 Nm] Note: Be sure to hold the knob still while installing the screw. The damper adjuster may be damaged if the knob is over torqued.



- 4 Clean fork and use a shock pump to set to desired pressure. Lightly pull the casing away from the CSA as you add air. See Mezzner Pro set-up sheet for recommended air pressures.

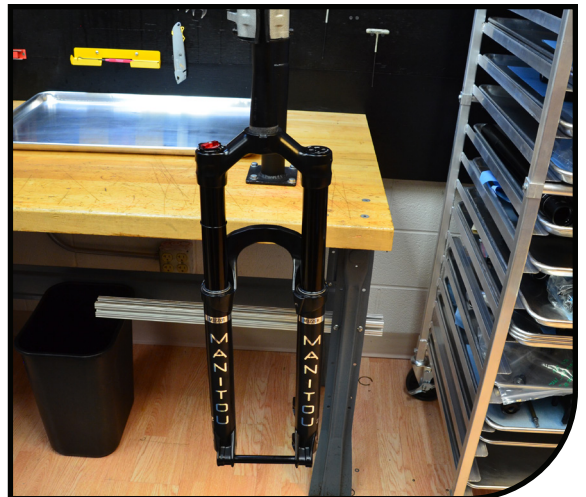

EXPERT DAMPER SERVICE

- 1 Using a 2mm Hex wrench remove the screw of the black VTT knob.

Note: Be sure to hold the knob still while removing the screw. The damper adjuster may be damaged if the knob is over torqued.



- 2 Use a non-marring pick or pliers with non-marring barrier to remove the black VTT knob by lifting straight up.



- 3 Remove the v-seal that was under the black VTT adjustment knob.



EXPERT DAMPER SERVICE

- 4** Use a standard cassette tool and 1" socket to unthread the damper top-cap from the stanchion.



- 5** Remove damper assembly from the stanchion. Inspect damper piston seal for any damage.



- 6** Tip out used damper oil from top of stanchion into drain pan. Cycle damper shaft several times to cycle out old oil from damper.



EXPERT CASTING INSTALL

- 1 Apply a light coating of semi-bath (85-0022) to the inner diameter of the oil seal/dust wiper.



- 2 Make sure the spring shaft is fully extended and air chamber is filled with air (60PSI).

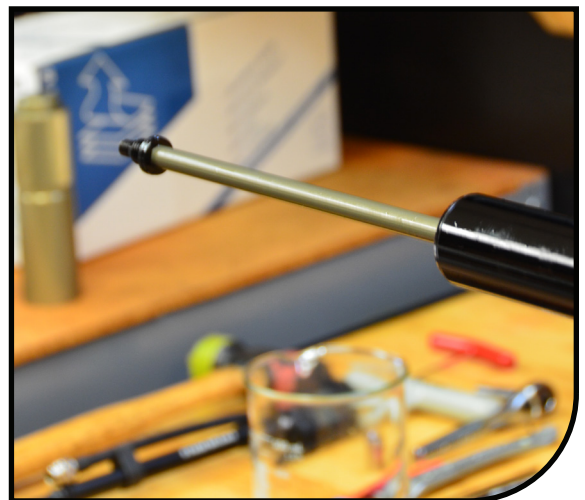

- 3 Fully extend the damper shaft.

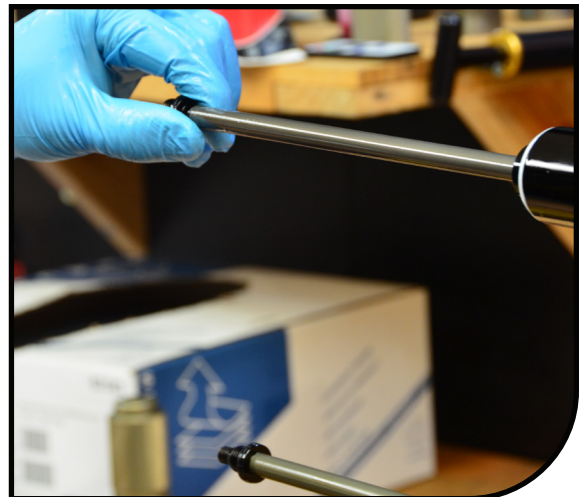

EXPERT CASTING INSTALL

- 4** Slide casting onto the stanchion assembly. Only slide the casting down about halfway at this point. Take care that the seal lips do not fold over upon installation.

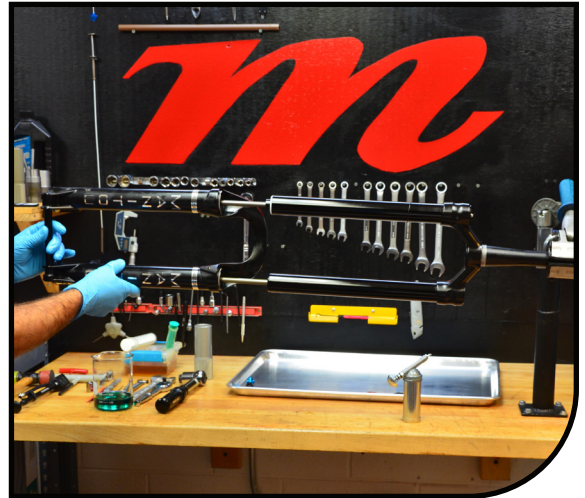

- 5** Insert 21cc of semi-bath (85-0022) into each casting leg. Once the semi-bath is in the legs slide the casting the rest of the way onto the stanchion assembly until the damper and spring shaft adapters pass thru the end of the casting. Some manual alignment may be needed.

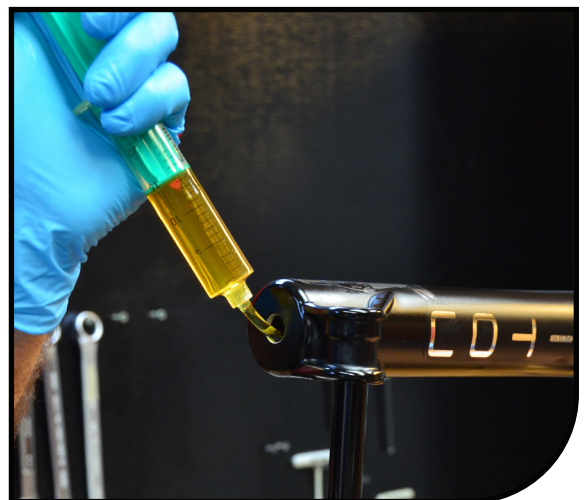

- 6** Thread the lock-nut onto the damper shaft adapter. Holding the lock-nut with a 14mm box wrench, use an 8mm Hex wrench to tighten the rebound damper adapter to 35–40 in-lb [3.95–4.5 Nm] by turning them **counter-clockwise**. Do not overtighten, doing so can damage the threads.

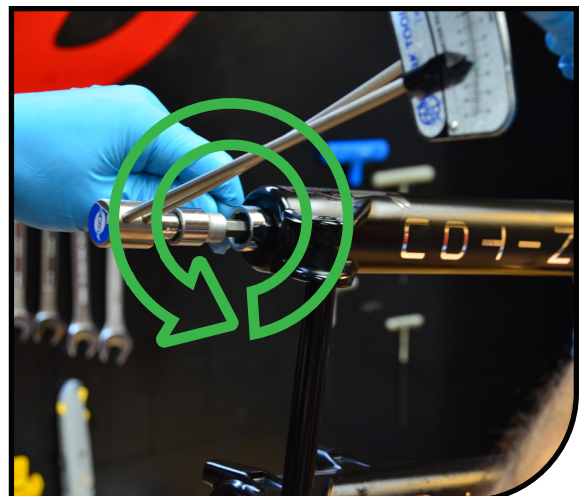

EXPERT CASTING INSTALL

- 7** Install the rebound knob using a 2mm Hex wrench. Add a small drop of blue Loctite to the screw before installation to prevent the screw from backing out during riding.

Note: Be sure to hold the knob still while removing the screw. The damper adjuster may be damaged if the knob is over torqued.



- 8** Thread the other lock-nut onto the spring shaft adapter. Holding the lock-nut with a 14mm box wrench, use an 8mm socket tighten the compression rod adapter to 35–40 in-lb [3.95–4.5 Nm] by turning them **counter-clockwise**. Do not overtighten, doing so can damage the threads.

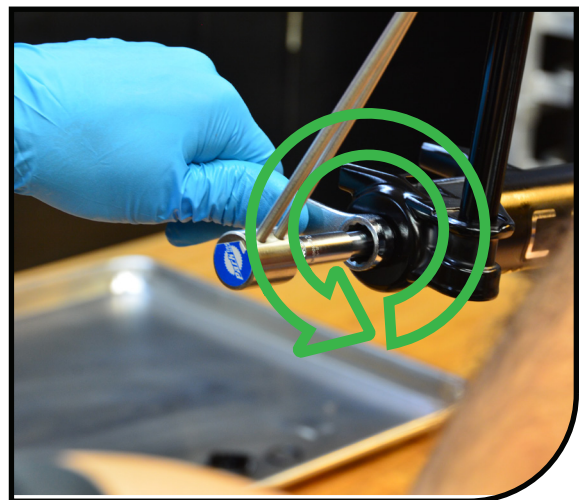

EXPERT DAMPER INSTALL

- 1 Fill damper leg about 3/4 full with Maxima fork oil.



- 2 Install the axle into the fork without a hub or wheel. Cover the damper leg opening with a lint-free towel. Using a wood block or similar raised support underneath the axle, compress the fork 10-15 times.

The raised support should be wide enough and long enough to safely support the axle as well as tall enough to eliminate contact between the floor and the air cap or rebound knob. Do not overtighten the axle bolt.

- 3 With the fork fully extended add oil to the height of 65mm measured from the top of the stanchion.

NOTE: OIL HEIGHT IS SET WITH FORK FULL EXTENDED AND CASTING INSTALLED

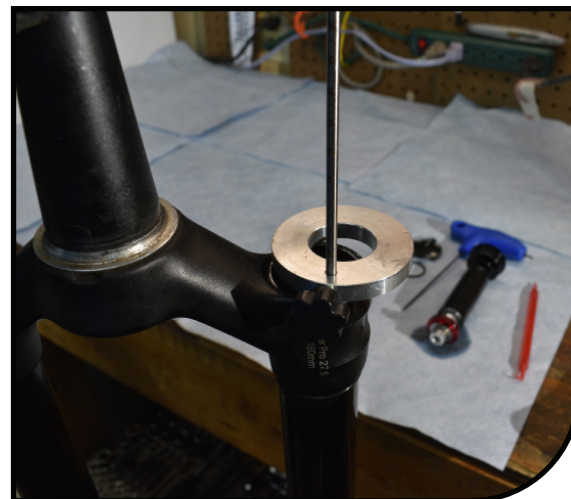

EXPERT DAMPER INSTALL

- 4** With the Vtt adjuster in the OPEN/ full counter clockwise position, install damper assembly into stanchion. Using a standard cassette lock-ring tool Torque to 200-220 inlb [20-25 Nm]



- 5** Clean the adjuster knobs with isopropyl and replace v-seal into damper top cap. Install the black VTT adjustment knob onto adjuster hex, being sure the knob can fully rotate without contacting the crown. With a 2mm hex, thread on the screw and torque to 4-6 in-lb [0.5-0.7 Nm] Note: Be sure to hold the knob still while installing the screw. The damper adjuster may be damaged if the knob is over torqued.



- 6** Clean fork and use a shock pump to set to desired pressure. Lightly pull the casing away from the CSA as you add air. See Mezzner Expert set-up sheet for recommended air pressures.





TRAVEL CHANGE GUIDE

MEZZER TRAVEL CHANGE

In order to change the travel of your Mezzar Pro or Expert (27.5 & 29), first remove the compression rod assembly. For instructions on how to do this refer to page 9-13. For travel change on new forks, bath oil may be preserved by removing stanchion assembly while fork is placed flat on benchtop. Once the rod is removed arrange the travel spacers into the desired amount of travel using the following charts.

MEZZER PRO AND EXPERT TRAVEL ADJUSTMENT

Increasing Travel: Each spacer pair (Two Halfs) removed Increase travel & Axel-To-Crown by 10mm

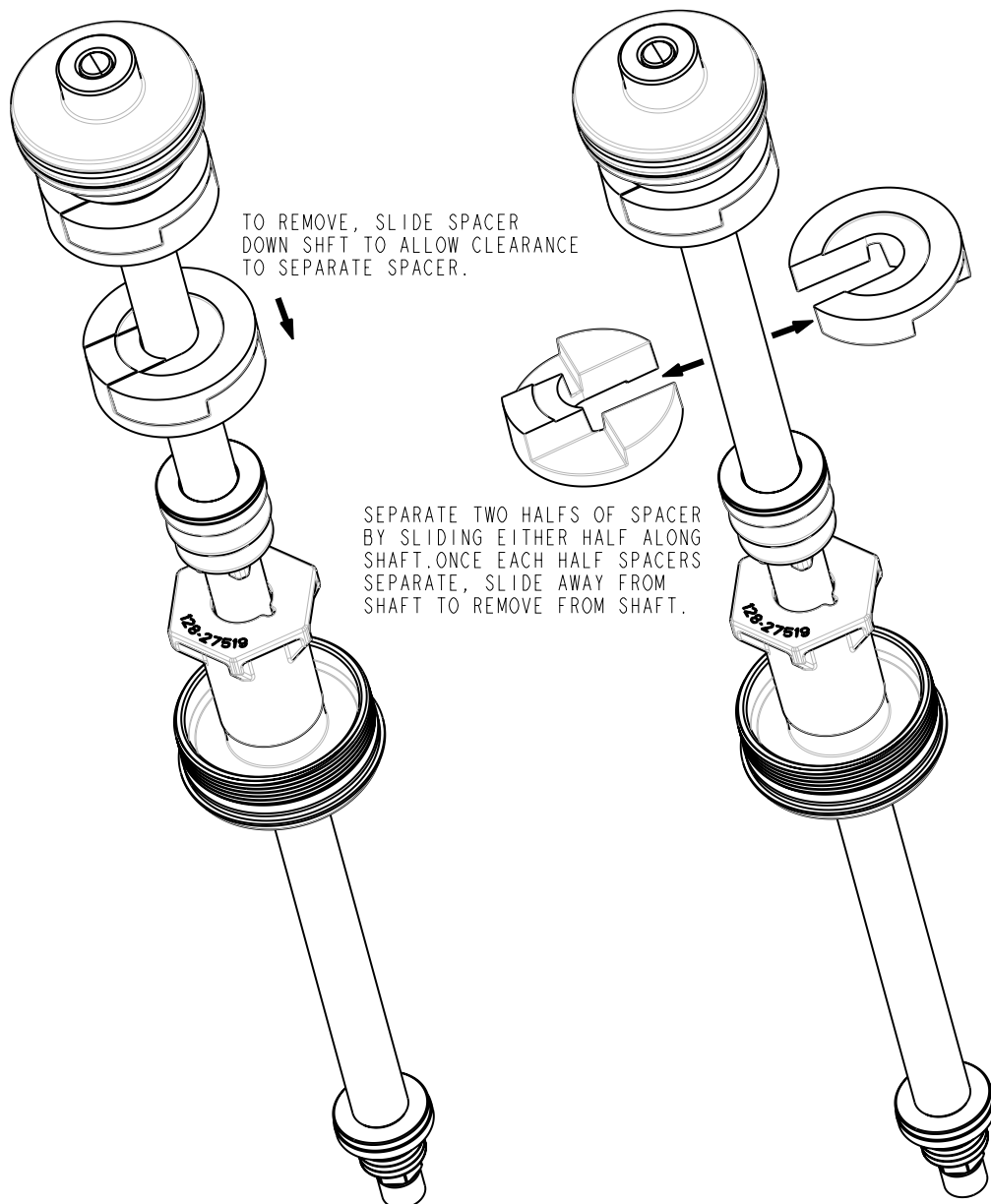

MEZZER TRAVEL CHANGE

MEZZER PRO ANDEXPERT TRAVEL ADJUSTMENT

Decrease Travel: Each spacer pair (Two Halfs) added decreases travel & Axle-To-Crown by 10mm

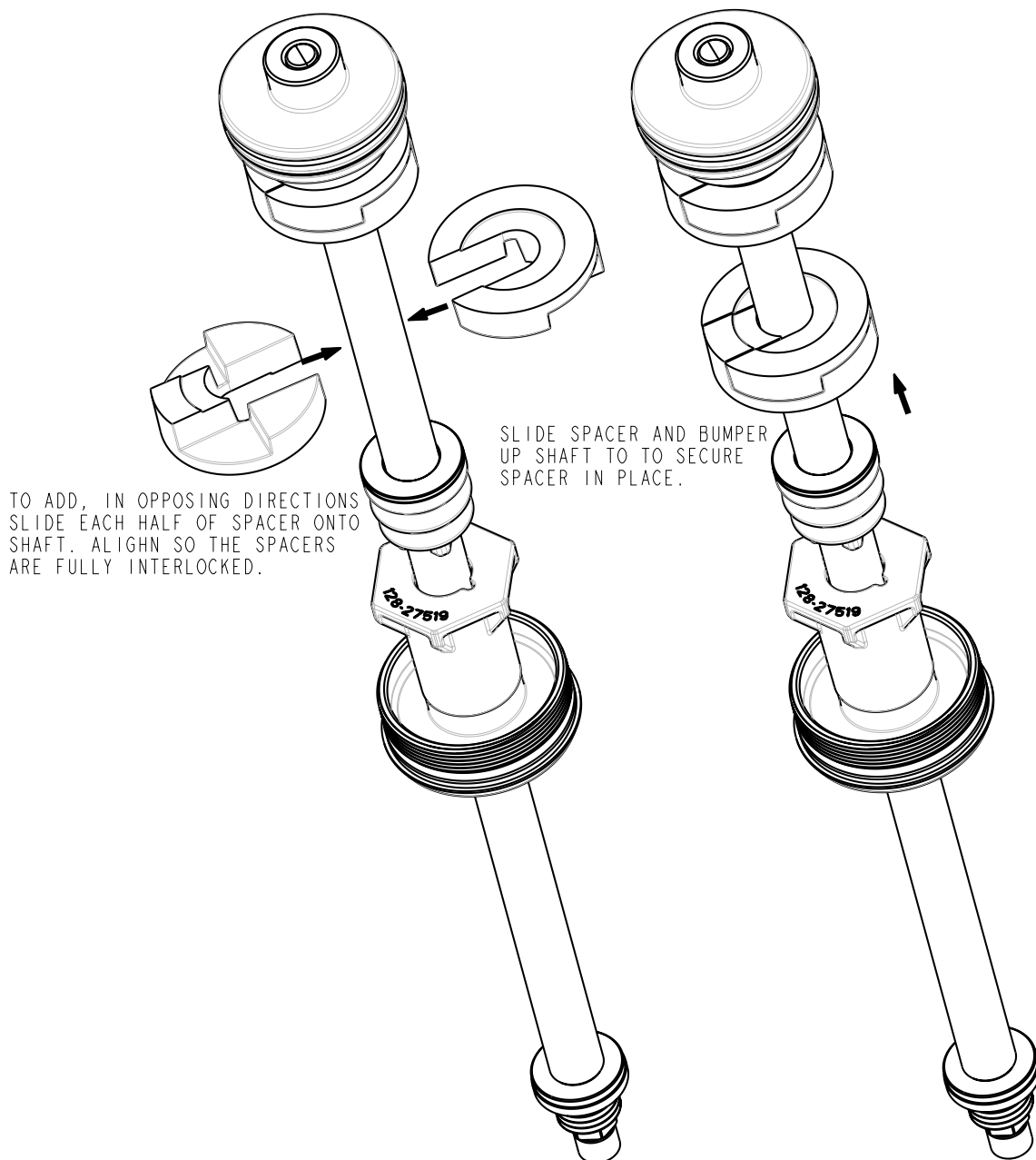

MEZZER TRAVEL CHANGE

Mezzer Pro, Dorado Air and Mezzer Expert, Expert Air

180MM

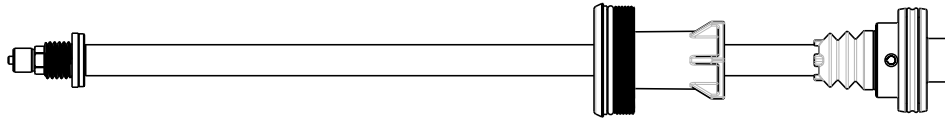

170MM

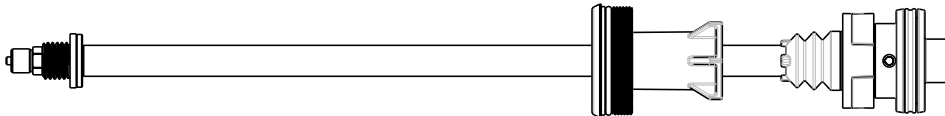

160MM

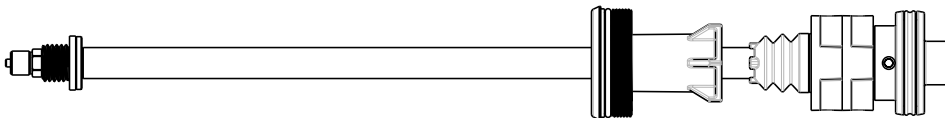

150MM

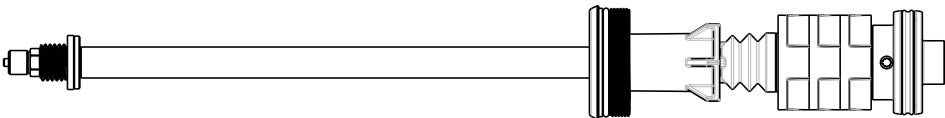

140MM

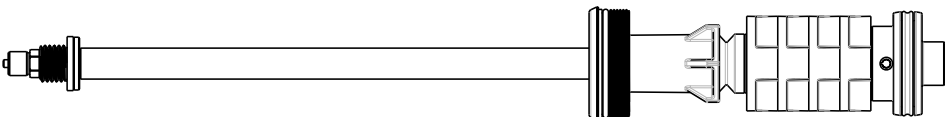

MEZZER EXPERT IVA SETTINGS

Standard IVA configurations for each travel

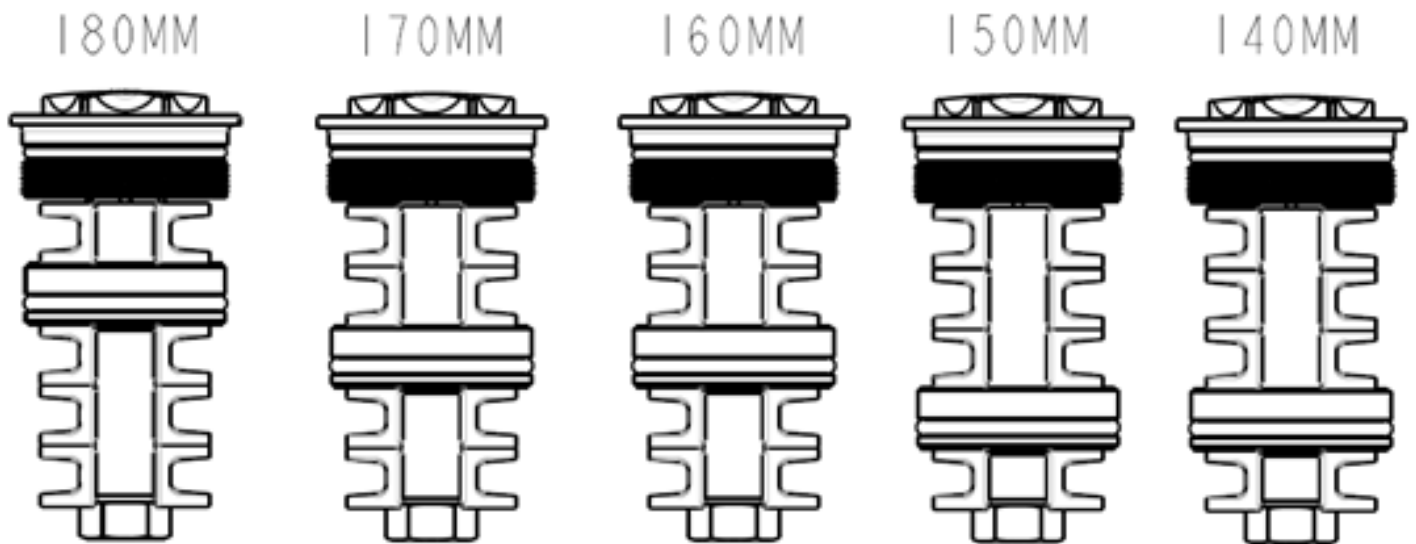

The air volume is modified by removing the clip-on spacers from the IVA shaft moving the piston into the desired location and reassembling the clip-on spacers to secure the piston on the IVA shaft.

Increasing the air volume (moving piston towards the top cap) creates a more linear spring curve with reduced mid-stroke support and end-stroke ramp-up.

Reducing the air volume (moving piston away from the top cap) creates a more progressive spring curve with increased mid-stroke support and end-stroke ramp-up.

MEZZER EXPERT 27.5" EXPLODED VIEW

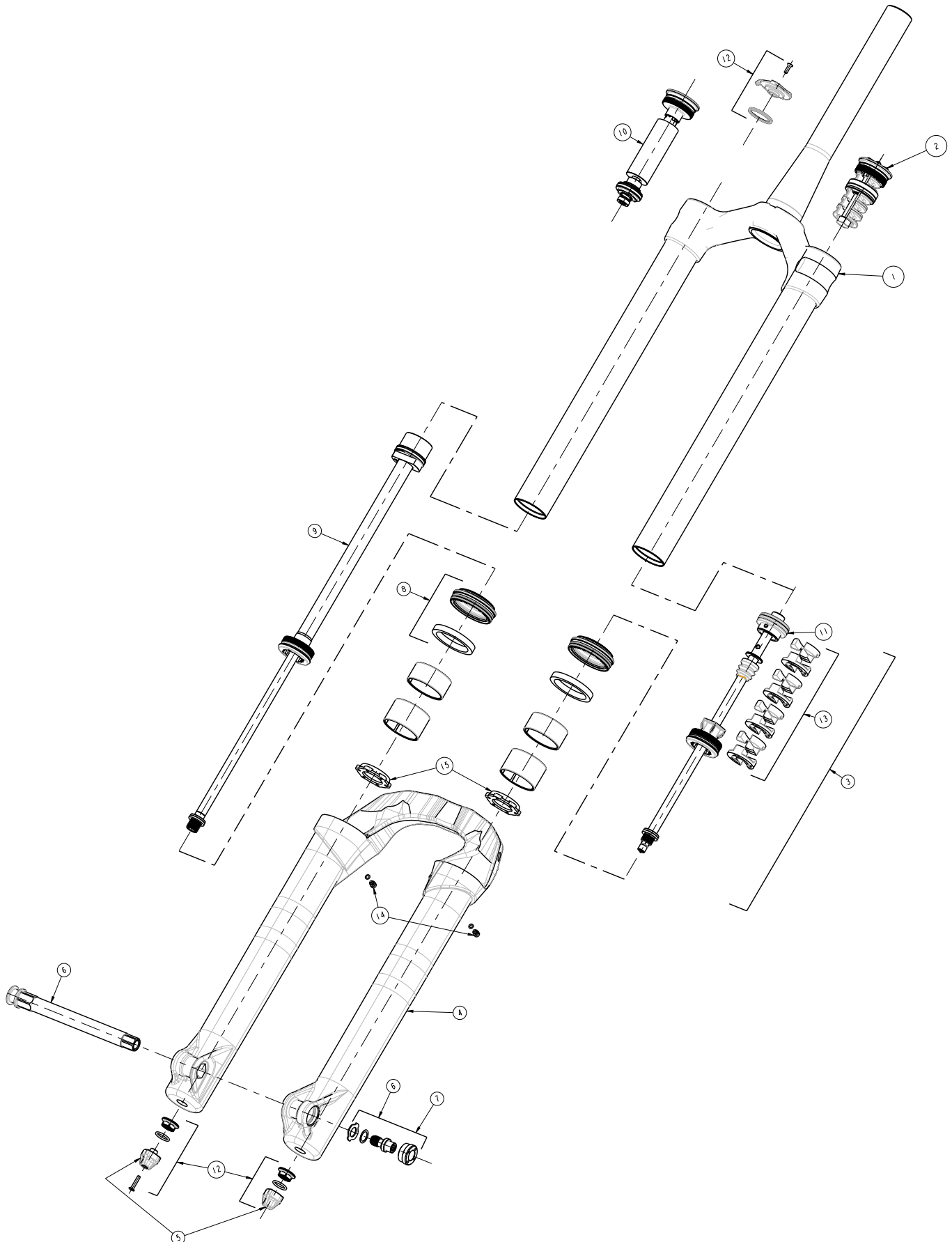

MEZZER EXPERT 27.5" EXPLODED VIEW

ITEM	PART DESCRIPTION	KIT NUMBER
1	CROWN STEER ASSY, 440S MBLK	141-36713-K001
	CROWN STEER ASSY, 370S MBLK	141-36713-K005
2	IVA ASSY	141-36713-K031
3	AIR SPRING ASSY (INCLUDES TRAVEL SPACERS)	141-36713-K020
4	CASTING ASSY, 27.5 MBLK REV B, WITHOUT AXLE	141-36713-K012
5	REBOUND KNOB / AIR VALVE KIT	141-32155-K016
6	HEXLOCK SL2 AXLE 110MM (WITH HARDWARE)	141-33147-K005
7	HEXLOCK SL2 AXLE HARDWARE	141-33147-K003
8	SEAL KIT 37MM	141-36713-K025
9	DAMPER ASSY, REBOUND MEZZER EXPERT (WITH KNOBS)	141-36713-K030
10	DAMPER ASSY, VTT MEZZER EXPERT (WITH KNOBS)	141-36713-K029
11	SEAL PISTON KIT, DORADO AIR MEZZER PRO/EXPERT	141-36713-K027
12	KNOB KIT, MEZZER EXPERT RB VTT	141-36713-K033
13	TRAVEL ADJUST SPACER KIT	141-36713-K032
14	BLEED SCREW, 2PC	141-36713-K035
15	BUMPER, BOTTOM-OUT REV B, 2PC	141-36713-K036
	FENDER AND HOSE GUIDE KIT	141-36103-K001
	REBUILD MEZZER PRO/EXPERT KIT	141-36713-K026
	DECAL KIT (EXPERT)	141-36713-K037
	QR15 AXLE HARDWARE	141-28131-K024
	QR15 AXLE 110 (WITHOUT HARDWARE)	141-32155-K011
	QR15 AXLE 110 WITH HARDWARE	141-28131-K028
	KIT, HOSE GUIDE, MY20 MEZZER/JUNIT FORK	141-36103-K003

MEEZER EXPERT 29" EXPLODED VIEW

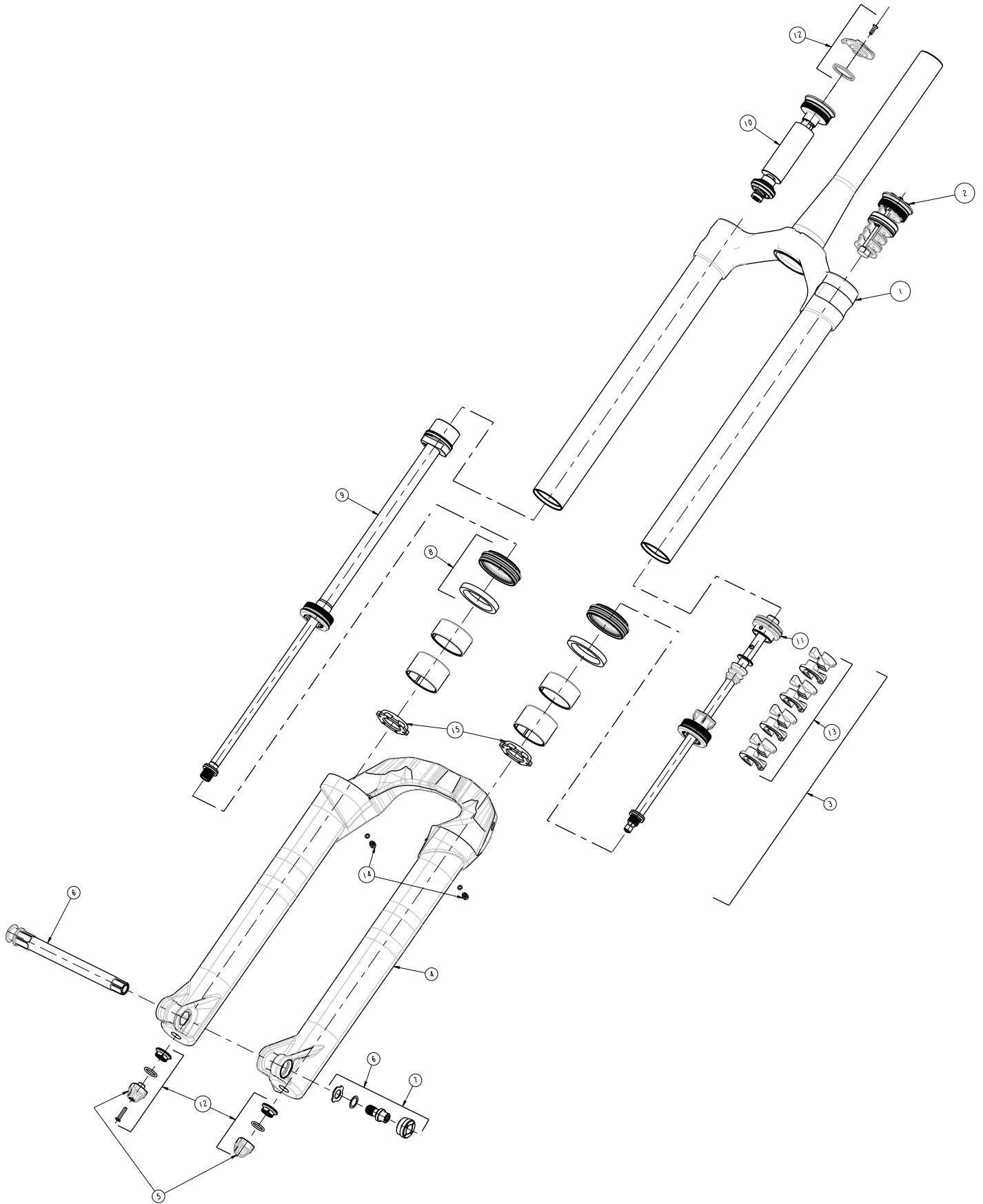

MEZZER EXPERT 29" EXPLODED VIEW

ITEM	PART DESCRIPTION	KIT NUMBER
1	CROWN STEER ASSY, 510S MBLK	141-36713-K001
	CROWN STEER ASSY, 440S MBLK	141-36713-K005
2	IVA ASSY	141-36713-K031
3	AIR SPRING ASSY (INCLUDES TRAVEL SPACERS)	141-36713-K020
4	CASTING ASSY, 29 MBLK REV B, WITHOUT AXLE	141-36713-K016
5	REBOUND KNOB / AIR VALVE KIT	141-32155-K016
6	HEXLOCK SL2 AXLE 110MM (WITH HARDWARE)	141-33147-K005
7	HEXLOCK SL2 AXLE HARDWARE	141-33147-K003
8	SEAL KIT 37MM	141-36713-K025
9	DAMPER ASSY, REBOUND MEZZER EXPERT (WITH KNOBS)	141-36713-K030
10	DAMPER ASSY, VTT MEZZER EXPERT (WITH KNOBS)	141-36713-K029
11	SEAL PISTON KIT, DORADO AIR MEZZER PRO/EXPERT	141-36713-K027
12	KNOB KIT, MEZZER EXPERT RB VTT	141-36713-K033
13	TRAVEL ADJUST SPACER KIT	141-36713-K032
14	BLEED SCREW, 2PC	141-36713-K035
15	BUMPER, BOTTOM-OUT REV B, 2PC	141-36713-K036
	FENDER AND HOSE GUIDE KIT	141-36103-K001
	REBUILD MEZZER PRO/EXPERT KIT	141-36713-K026
	DECAL KIT (EXPERT)	141-36713-K037
	QR15 AXLE HARDWARE	141-28131-K024
	QR15 AXLE 110 (WITHOUT HARDWARE)	141-32155-K011
	QR15 AXLE 110 WITH HARDWARE	141-28131-K028
	KIT, HOSE GUIDE, MY20 MEZZER/JUNIT FORK	141-36103-K003

MEZZER PRO 27.5" EXPLODED VIEW

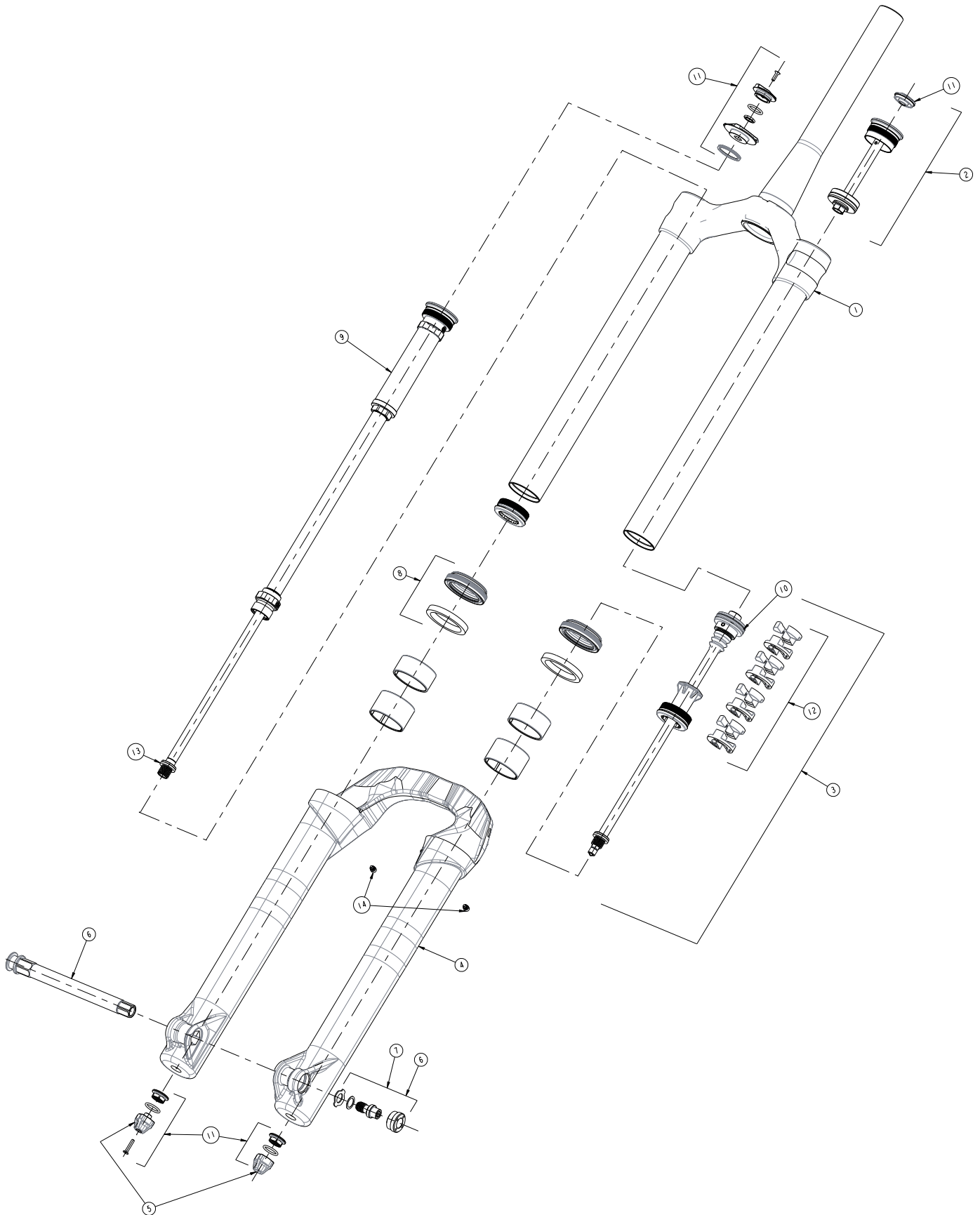

MEZZER PRO 27.5" EXPLODED VIEW

ITEM	PART DESCRIPTION	KIT NUMBER
1	CROWN STEER ASSY, 440S MBLK	141-36713-K001
	CROWN STEER ASSY, 370S MBLK	141-36713-K005
2	IRT ASSY	141-36713-K021
3	AIR SPRING ASSY (INCLUDES TRAVEL SPACERS)	141-36713-K020
4	CASTING ASSY, 27.5 MBLK REV B, WITHOUT AXLE	141-36713-K012
5	REBOUND KNOB / AIR VALVE KIT	141-32155-K016
6	HEXLOCK SL2 AXLE 110MM (WITH HARDWARE)	141-33147-K005
7	HEXLOCK SL2 AXLE HARDWARE	141-33147-K003
8	SEAL KIT 37MM	141-36713-K025
9	DAMPER ASSY, MC2 MEZZER PRE-BLED (WITH KNOBS)	141-36713-K022
10	SEAL PISTON KIT, DORADO AIR MEZZER PRO/EXPERT	141-36713-K027
11	KNOB KIT, MEZZER PRO IRT RB MC2/VTT	141-36713-K024
12	TRAVEL ADJUST SPACER KIT	141-36713-K032
13	REBOUND ADAPTER	141-36713-K034
14	BLEED SCREW, 2PC	141-36713-K035
	FENDER AND HOSE GUIDE KIT	141-36103-K001
	REBUILD MEZZER PRO/EXPERT KIT	141-36713-K026
	DECAL KIT	141-36713-K028
	QR15 AXLE HARDWARE	141-28131-K024
	QR15 AXLE 110 (WITHOUT HARDWARE)	141-32155-K011
	QR15 AXLE 110 WITH HARDWARE	141-28131-K028
	KIT, HOSE GUIDE, MY20 MEZZER/JUNIT FORK	141-36103-K003

MEZZER PRO 29" EXPLODED VIEW

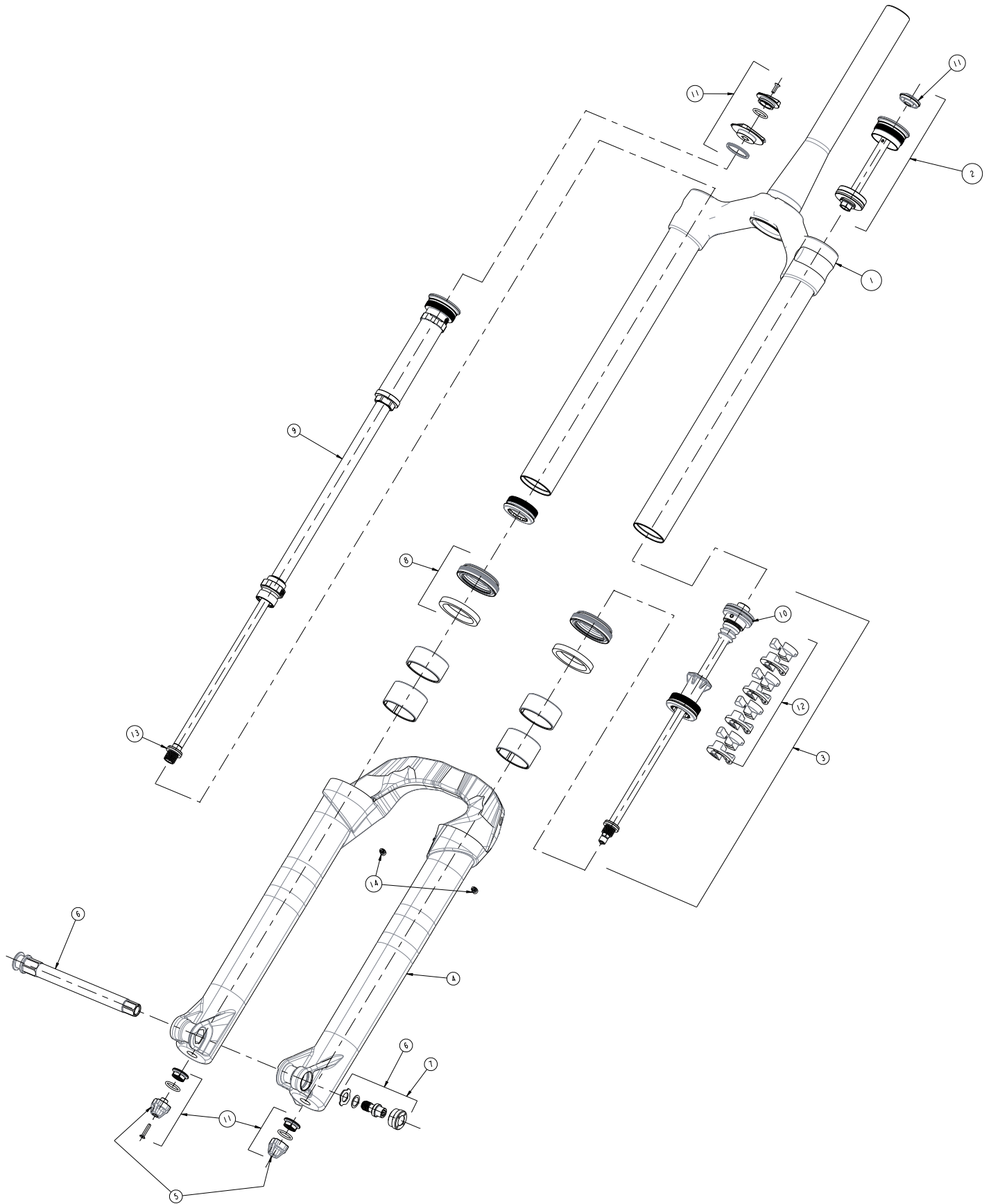

MEZZER PRO 29" EXPLODED VIEW

ITEM	PART DESCRIPTION	KIT NUMBER
1	CROWN STEER ASSY, 510S MBLK	141-36713-K001
	CROWN STEER ASSY, 440S MBLK	141-36713-K005
2	IRT ASSY	141-36713-K021
3	AIR SPRING ASSY (INCLUDES TRAVEL SPACERS)	141-36713-K020
4	CASTING ASSY, 29 MBLK REV B, WITHOUT AXLE	141-36713-K016
5	REBOUND KNOB / AIR VALVE KIT	141-32155-K016
6	HEXLOCK SL2 AXLE 110MM (WITH HARDWARE)	141-33147-K005
7	HEXLOCK SL2 AXLE HARDWARE	141-33147-K003
8	SEAL KIT 37MM	141-36713-K025
9	DAMPER ASSY, MC2 MEZZER PRE-BLED (WITH KNOBS)	141-36713-K022
10	SEAL PISTON KIT, DORADO AIR MEZZER PRO/EXPERT	141-36713-K027
11	KNOB KIT, MEZZER PRO IRT RB MC2/VTT	141-36713-K024
12	TRAVEL ADJUST SPACER KIT	141-36713-K032
13	REBOUND ADAPTER	141-36713-K034
14	BLEED SCREW, 2PC	141-36713-K035
15	FENDER AND HOSE GUIDE KIT	141-36103-K001
	REBUILD MEZZER PRO/EXPERT KIT	141-36713-K026
	DECAL KIT	141-36713-K028
	QR15 AXLE HARDWARE	141-28131-K024
	QR15 AXLE 110 (WITHOUT HARDWARE)	141-32155-K011
	QR15 AXLE 110 WITH HARDWARE	141-28131-K028
	KIT, HOSE GUIDE, MY20 MEZZER/JUNIT FORK	141-36103-K003



WWW.MANITOUMTB.COM WWW.HAYESCOMPONENTS.COM
5800 W DONGES BAY ROAD MEQUON WI 53092

46-38529 REV.A